



HK2016-AS1-B

Drawn cup needle roller bearing open end

Schaeffler ID:
0035930880000

Drawn cup needle roller bearing open end
HK...AS1-B, single row, with cage

Technical information

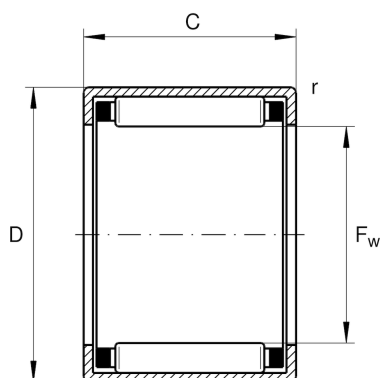

Main Dimensions & Performance Data

F_w	20 mm	Under roller diameter
D	26 mm	Outside diameter
C	16 mm	Width
C_r	12.700 N	Basic dynamic load rating, radial
C_{0r}	20.100 N	Basic static load rating, radial
C_{ur}	2.550 N	Fatigue load limit, radial
n_G	12.700 1/min	Limiting speed
$n_{G \text{ Grease}}$	7.600 1/min	Limiting speed for grease lubrication
n_{gr}	9.300 1/min	Reference speed
	18,83 g	Weight

Dimensions

r_{\min}	0,8 mm	Minimum chamfer dimension
------------	--------	---------------------------

Temperature range

T_{\min}	-30 °C	Operating temperature min.
T_{\max}	140 °C	Operating temperature max.

Additional information

SD20X26X4	Sealing ring
G20X26X4	Sealing ring 2
LR17X20X16,5	Suitable inner rings LR
IR17X20X16-XL	Suitable inner rings IR